

---

D  
ANDY  
HOME



The logo consists of the word 'D' in a large, white, serif font. Below it, the word 'ANDY' is written in a smaller, white, serif font. The letter 'Y' in 'ANDY' is stylized with a small Italian flag (green, white, and red horizontal stripes) integrated into its right side. Below the word 'ANDY', the word 'HOME' is written in a smaller, red, serif font.

---

"seno i dettagli. e crea lo stile"  
Vignoni

— "The Details create the style"

WELCOME IN **DANDY**  
HOME

The concept of "Dandy Home Collection" aims at living a unique fashion - oriented lifestyle. The exclusive character of the products is inspired by the world of fashion through new combinations of materials and details.

A great collection of Leather upholstered products and furniture accessories, created and managed by designer Giuseppe Viganò.

Dandy Home Collection is entirely manufactured in Italy and distributed by Gamma Arredamenti International S.p.A. all over the world.



Designer Giuseppe Viganò



GREGORY 4



COCOON 22



ESCAPE 48



KARL 58



NEXT 76



RENEGADE 86



HARLEY 8



LUNA 18



COCOON BERGÈRE 34



SPIDER 46



GLOSS 58



CHARLOTTE 61



LOVE 72



SCARLETT 82



BASKET LAMPS 6



BAGS 14



BIG BAG 16



COCOON NIGHT 38



ROYAL PILLOWS 44



SMART ACCESSORIES 45



SMART STOOLS 45



FLOOR PILLOWS 56



BROOKLYN BOOKSHELF 68



SALLY 71



COFFEE TABLES 4



COFFEE TABLES 9



COFFEE TABLES 12



COFFEE TABLES 14



COFFEE TABLES 40



COFFEE TABLES 41



COFFEE TABLES 52



COFFEE TABLES 90







































































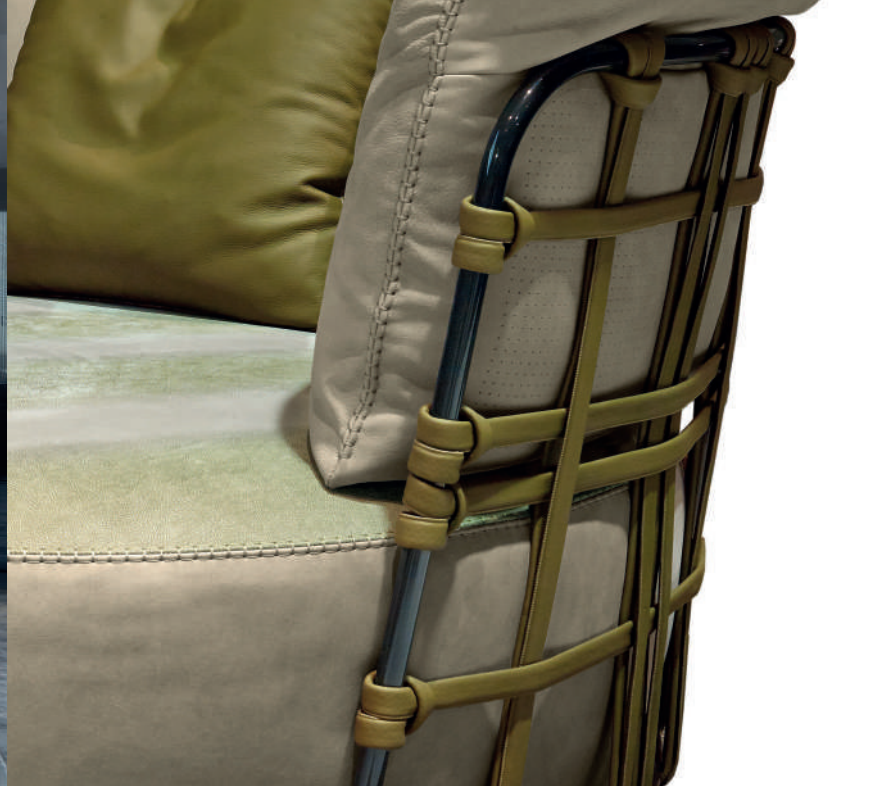

















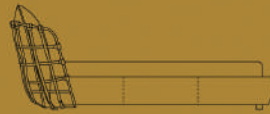
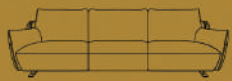

*Schematics*

# COCOON

Design Giuseppe Viganò

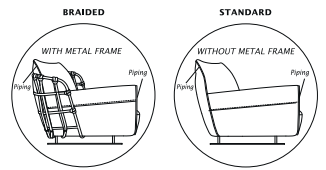
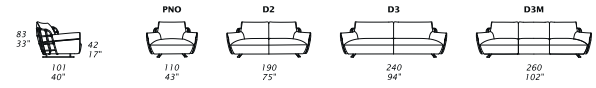

**X** all items in group X have the same seat width – tutti gli elementi del gruppo X hanno lo stesso modulo di seduta

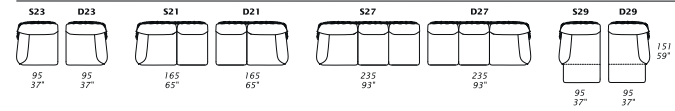

**J** all items in group J have the same seat width – tutti gli elementi del gruppo J hanno lo stesso modulo di seduta

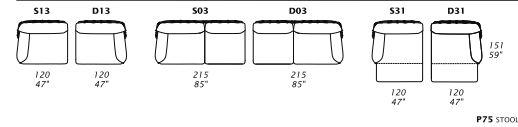

P75 STOOL

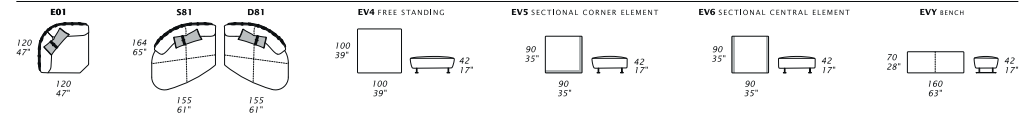

P77 STOOL

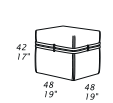

P78 TABLE

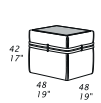

P79 MAGAZINE STORAGE

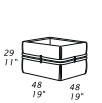

C0204 suggested lumbar pillow

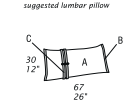

Dimensions: the first figure shows sizes in centimeters, the second in inches.  
 Each piece is made by hand and has its own uniqueness. Measures may vary with a tolerance up to 3%.  
 Mixing above groups (X - J) will create sectionals with different seat widths.  
 Corner pieces E01 and S81/D81 are odd pieces and can be used with all above groups X - J.  
 Seat depth 65 cm - 26".



# ESCAPE

Design Giuseppe Viganò

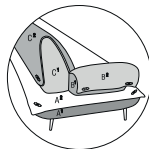
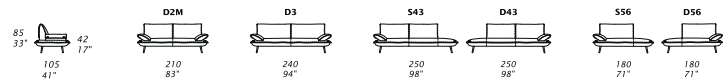

**Y** all items in group Y have the same seat width – tutti gli elementi del gruppo Y hanno lo stesso modulo di seduta

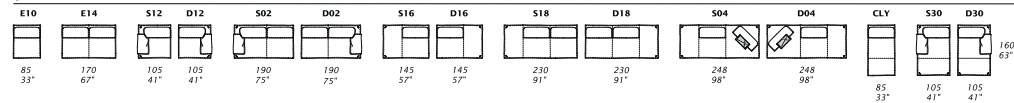

**J** all items in group J have the same seat width – tutti gli elementi del gruppo J hanno lo stesso modulo di seduta

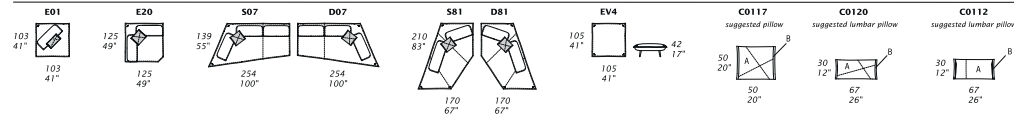
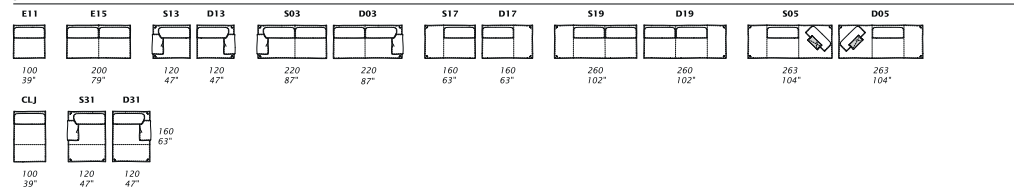

– THE PART B OF THE PILLOWS IS AVAILABLE IN: CUC S01C AND CUC S10B SPECIAL STITCHINGS

Dimensions: the first figure shows sizes in centimeters, the second in inches.  
 Each piece is made by hand and has its own uniqueness. Measures may vary with a tolerance up to 3%.  
 Mixing above groups (Y - J) will create sectionals with different seat widths.  
 Corner pieces E01, E20, S07/D07 and S81/D81 are odd pieces and can be used with all above groups Y - J.  
 Seat depth 65 cm - 26".

Technical sheet

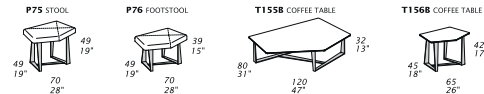

# GREGORY

Design Giuseppe Viganò

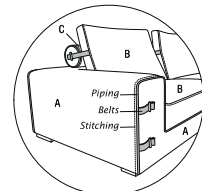
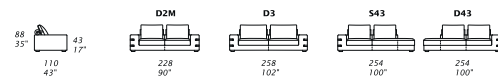

**Y** all items in group Y have the same seat width – tutti gli elementi del gruppo Y hanno lo stesso modulo di seduta

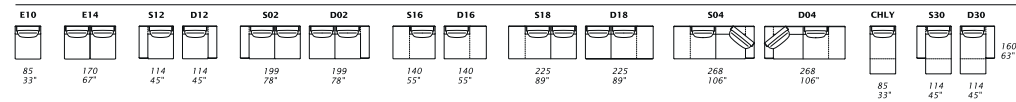

**J** all items in group J have the same seat width – tutti gli elementi del gruppo J hanno lo stesso modulo di seduta

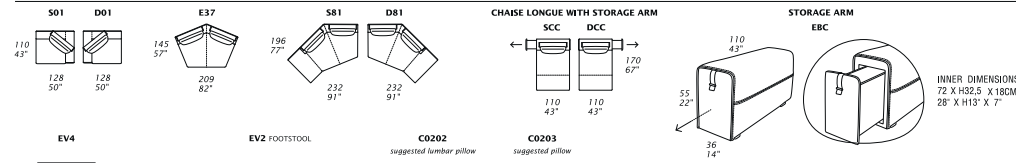
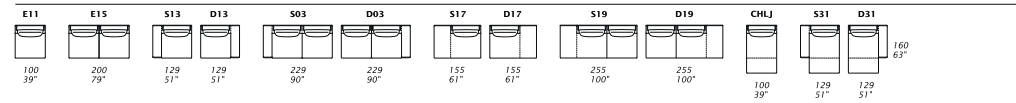

INNER DIMENSIONS:  
 72" X H32.5" X 18CM  
 28" X H13" X 7"

Dimensions: the first figure shows sizes in centimeters, the second in inches.  
 Each piece is made by hand and has its own uniqueness. Measures may vary with a tolerance up to 3%.  
 Mixing above groups (Y - J) will create sectionals with different seat widths.  
 Corner pieces S01/D01, E37 and S81/D81 are odd pieces and can be used with all above groups Y - J.  
 Seat depth 68 cm - 27".

Technical sheet

EV4, EV2 AND C0203 STANDARD WITH TUFTING

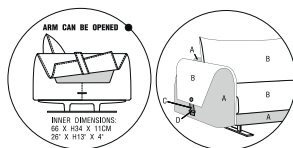
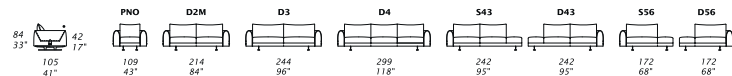

**Y** all items in group Y have the same seat width – tutti gli elementi del gruppo Y hanno lo stesso modulo di seduta

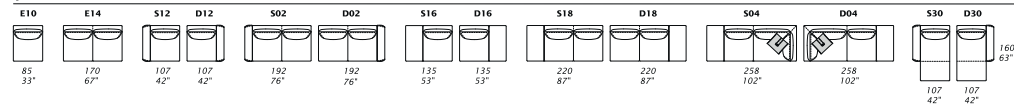

**J** all items in group J have the same seat width – tutti gli elementi del gruppo J hanno lo stesso modulo di seduta

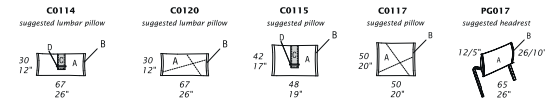
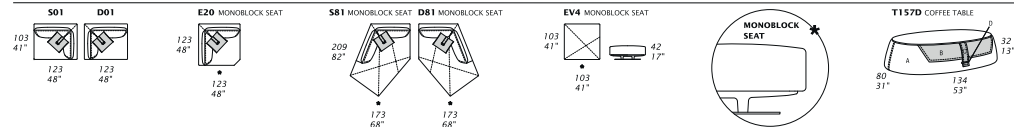
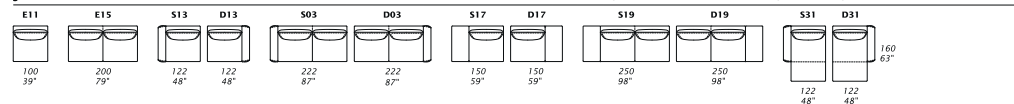

...THE PART B OF THE PILLOWS IS AVAILABLE IN: CUC S01C AND CUC S108 SPECIAL STITCHINGS

Dimensions: the first figure shows sizes in centimeters, the second in inches.  
Each piece is made by hand and has its own uniqueness. Measures may vary with a tolerance up to 3%.  
Mixing above groups (Y - J) will create sectionals with different seat widths.  
Corner pieces S01/D01, E20 and S81/D81 are odd pieces and can be used with all above groups Y - J.  
Seat depth 60 cm - 24".

Technical sheet

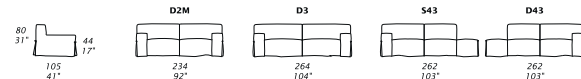

**Y** all items in group Y have the same seat width – tutti gli elementi del gruppo Y hanno lo stesso modulo di seduta

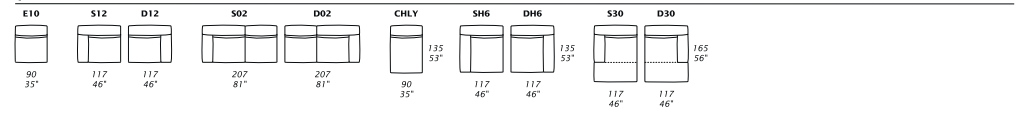

**J** all items in group J have the same seat width – tutti gli elementi del gruppo J hanno lo stesso modulo di seduta

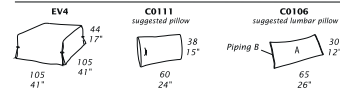
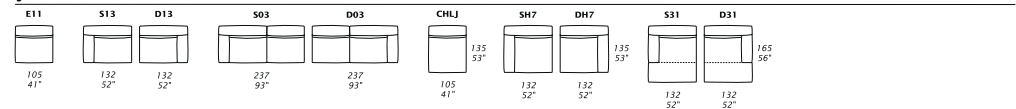

Dimensions: the first figure shows sizes in centimeters, the second in inches.  
Each piece is made by hand and has its own uniqueness. Measures may vary with a tolerance up to 3%.  
Mixing above groups (Y - J) will create sectionals with different seat widths.  
Seat depth 66 cm - 26".

Technical sheet

# RENEGADE

Design Giuseppe Viganò

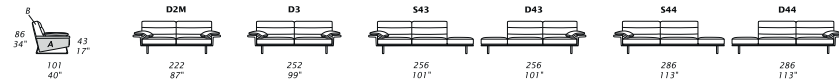

**Y** all items in group Y have the same seat width – tutti gli elementi del gruppo Y hanno lo stesso modulo di seduta

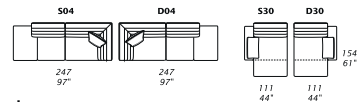
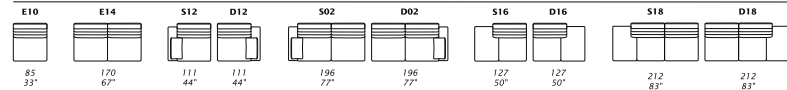

**J** all items in group J have the same seat width – tutti gli elementi del gruppo J hanno lo stesso modulo di seduta

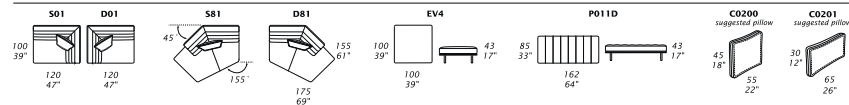
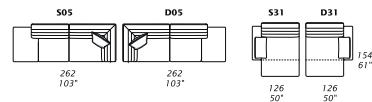
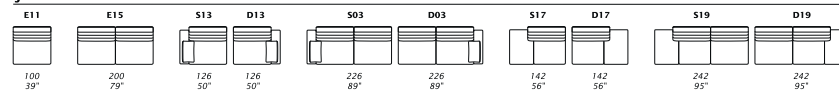

Dimensions: the first figure shows sizes in centimeters, the second in inches.  
Each piece is made by hand and has its own uniqueness. Measures may vary with a tolerance up to 3%.  
Mixing above groups (Y - J) will create sectionals with different seat widths.  
Corner pieces S01/D01 and S81/D81 are odd pieces and can be used with all above groups Y - J.  
Seat depth 62 cm - 24".

# COCOON NIGHT

Design Giuseppe Viganò

BRAIDED

STANDARD

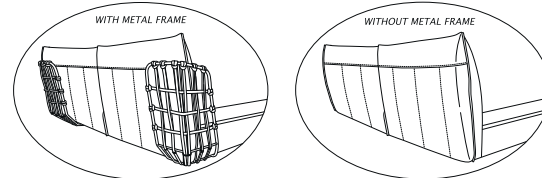

EUROPEAN SIZES

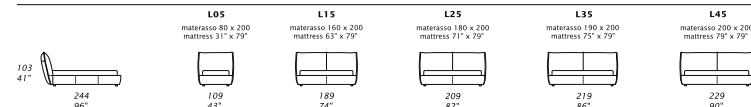

AMERICAN SIZES

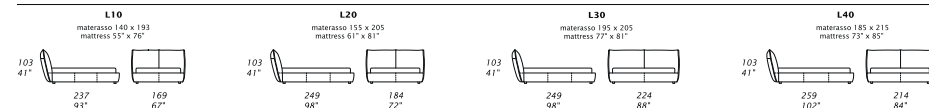

P020D BENCH

BRAIDED VERSION

BHB BRAIDED CORNERS

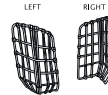
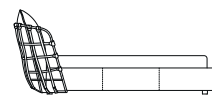
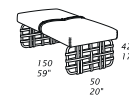

– IN THE BRAIDED VERSION THE DIMENSIONS WILL BE INCREASED OF 8 CM - 3" IN WIDTH AND 4 CM - 2" IN DEPTH

Dimensions: the first figure shows sizes in centimeters, the second in inches.

Each piece is made by hand and has its own uniqueness. Measures may vary with a tolerance up to 3%.

Base height 35 cm - 14".

Wood legs, height 6 cm - 2".

Technical sheet

# COCOON BERGÈRE

Design Giuseppe Viganò

## STANDARD FEATURES

- METAL FRAME AND BASE AVAILABLE IN:  
CHROME, DARK CHROME-TITANIO, BURNISHED ALUMINIUM, BURNISHED COPPER OR PAINTED METAL

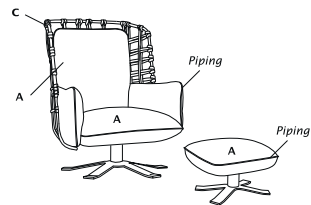

**POL**  
(swivel)

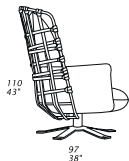

110  
43"

97  
38"



96  
38"

**EV1**



39  
15"

50  
20"



60  
24"

Dimensions: the first figure shows sizes in centimeters, the second in inches.

Each piece is made by hand and has its own uniqueness. Measures may vary with a tolerance up to 3%.

Seat depth 55 cm - 22".

Seat height 43 cm - 17".

Technical sheet

# CHARLOTTE

Design Giuseppe Viganò

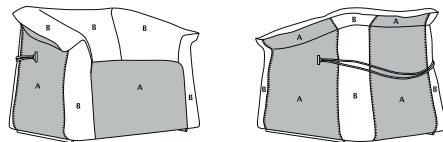

**PNA**

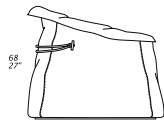

68  
27"

82  
32"

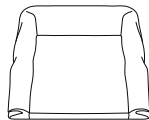

88  
35"

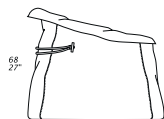

68  
27"

82  
32"

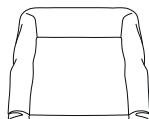

88  
35"

**POL**  
(swivel)

Dimensions: the first figure shows sizes in centimeters, the second in inches.

Each piece is made by hand and has its own uniqueness. Measures may vary with a tolerance up to 3%.

Seat depth 53 cm - 21".

Seat height 39 cm - 15".

Technical sheet

# GLOSS

Design Giuseppe Viganò

## STANDARD FEATURES

- POL: PAINTED FRAME AND METAL SWIVEL BASE AVAILABLE IN:  
METALLIC GREY, METALLIC ANTHRACITE, SIGNAL WHITE, SILK GREY, WINE RED, GREY BROWN, JET BLACK

- POS: FRAME COVERED WITH LEATHER AND METAL SWIVEL BASE AVAILABLE IN:  
METALLIC GREY, METALLIC ANTHRACITE, SIGNAL WHITE, SILK GREY, WINE RED, GREY BROWN, JET BLACK

## NOTE

- AVAILABLE CHROME, DARK CHROME-TITANIO, BURNISHED ALUMINIUM OR BURNISHED COPPER METAL SWIVEL BASE

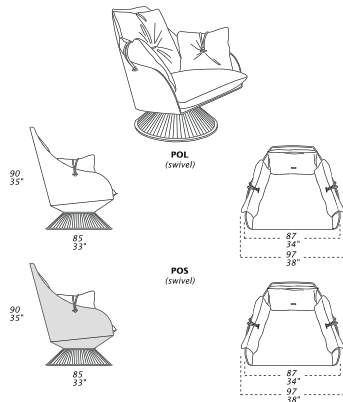

**POL**  
(swivel)

90  
35"

85  
33"

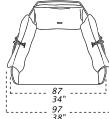

87  
34"

97  
38"

**POS**  
(swivel)

90  
35"

85  
33"

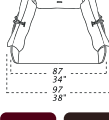

87  
34"

97  
38"



Metallic Grey

Metallic Anthracite

RAL 9005 - Signal White

RAL 7041 - Silk Grey

RAL 3005 - Wine Red

RAL 8019 - Grey Brown

RAL 9005 - Jet Black

Dimensions: the first figure shows sizes in centimeters, the second in inches.

Each piece is made by hand and has its own uniqueness. Measures may vary with a tolerance up to 3%.

Seat depth 61 cm - 24".

Seat height 44 cm - 17".

Technical sheet

# HARLEY

Design Giuseppe Viganò

## STANDARD FEATURES

- METAL SWIVEL BASE AVAILABLE IN:  
DARK CHROME-TITANIO, BURNISHED ALUMINIUM OR BURNISHED COPPER



**POL**  
(swivel)

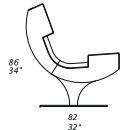

86  
34"

82  
32"

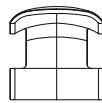

78  
31"

Dimensions: the first figure shows sizes in centimeters, the second in inches.

Each piece is made by hand and has its own uniqueness. Measures may vary with a tolerance up to 3%.

Seat depth 54 cm - 21".

Seat height 41 cm - 16".

Technical sheet

# LOVE

Design Giuseppe Viganò

## STANDARD FEATURES

- METAL FRAME AVAILABLE IN:  
CHROME, DARK CHROME-TITANIO, BURNISHED ALUMINIUM, BURNISHED COPPER OR PAINTED METAL

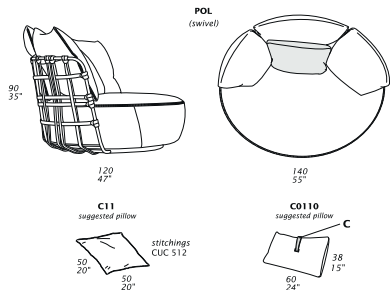
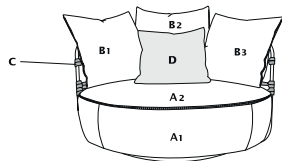

Dimensions: the first figure shows sizes in centimeters, the second in inches.  
Each piece is made by hand and has its own uniqueness. Measures may vary with a tolerance up to 3%.  
Seat depth 72 cm - 28".  
Seat height 42 cm - 17".

Technical sheet

# LUNA

Design Giuseppe Viganò

## STANDARD FEATURES

- METAL SWIVEL BASE AND LEGS AVAILABLE IN:  
CHROME, DARK CHROME-TITANIO, BURNISHED ALUMINIUM, BURNISHED COPPER OR PAINTED METAL

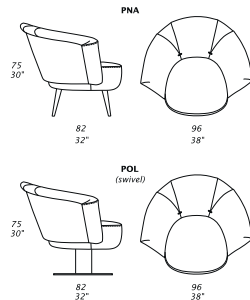
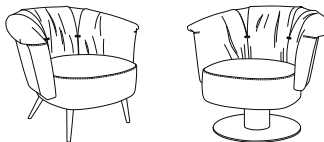

Dimensions: the first figure shows sizes in centimeters, the second in inches.  
Each piece is made by hand and has its own uniqueness. Measures may vary with a tolerance up to 3%.  
Seat depth 60 cm - 24".  
Seat height 45 cm - 18".

Technical sheet

# SCARLETT

Design Giuseppe Viganò

## STANDARD FEATURES

- STEEL STRUCTURE, PADDED WITH MOULDED POLYURETHANE FOAM AND COVERED WITH A THIN FEATHER LINING  
- METAL LEGS AVAILABLE IN:  
CHROME, DARK CHROME-TITANIO, BURNISHED ALUMINIUM, BURNISHED COPPER OR PAINTED METAL

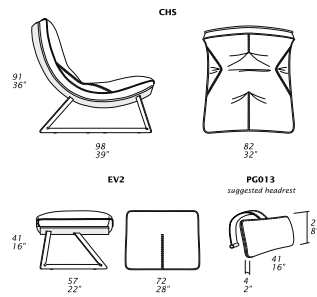
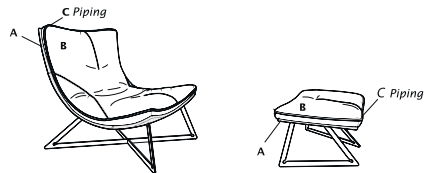

Dimensions: the first figure shows sizes in centimeters, the second in inches.  
Each piece is made by hand and has its own uniqueness. Measures may vary with a tolerance up to 3%.  
Seat depth 58 cm - 23".  
Seat height 42 cm - 17".

Technical sheet

# SPIDER

Design Giuseppe Viganò

## STANDARD FEATURES

- METAL FRAME AVAILABLE IN:  
CHROME, DARK CHROME-TITANIO, BURNISHED ALUMINIUM, BURNISHED COPPER OR PAINTED METAL

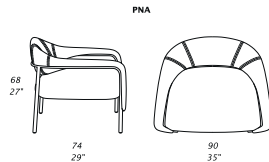
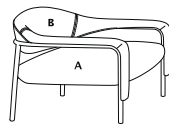

Dimensions: the first figure shows sizes in centimeters, the second in inches.  
Each piece is made by hand and has its own uniqueness. Measures may vary with a tolerance up to 3%.  
Seat depth 60 cm - 24".  
Seat height 41 cm - 16".

Technical sheet

# SALLY CHAIR

Design Giuseppe Viganò

## STANDARD FEATURES

- METAL LEGS AND BUTTON AVAILABLE IN:  
CHROME, DARK CHROME-TITANIO, BURNISHED ALUMINIUM, BURNISHED COPPER OR PAINTED METAL

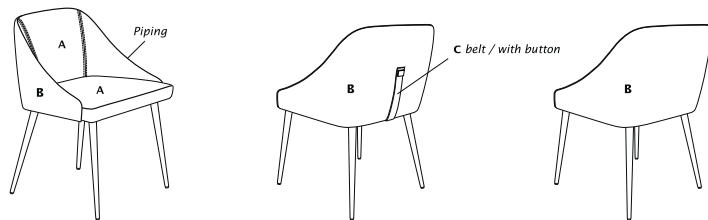

CHR

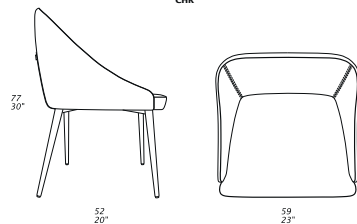

Dimensions: the first figure shows sizes in centimeters, the second in inches.  
Each piece is made by hand and has its own uniqueness. Measures may vary with a tolerance up to 3%.  
Seat depth 42 cm - 17".  
Seat height 50 cm - 20".

Technical sheet

# COFFEE TABLES

Design Giuseppe Viganò

## STANDARD FEATURES

- BASE AVAILABLE IN: CHROME, DARK CHROME-TITANIO, BURNISHED ALUMINIUM, BURNISHED COPPER, PAINTED METAL OR COVERED WITH LEATHER  
- BUCKLE AVAILABLE IN: CHROME, DARK CHROME-TITANIO, BURNISHED ALUMINIUM, BURNISHED COPPER, PAINTED METAL OR COVERED WITH LEATHER  
- GLASS TOP AVAILABLE IN: SMOKED OR WHITE (RAL 9003)

## NOTES

- CERAMIC TOP AVAILABLE IN:  
TERRA, ANTRACITE, NOIR DESIR OR OSSIDO BRUNO COLOR (CERAMIC TOP NOT AVAILABLE FOR T07)

- MARBLE TOP AVAILABLE IN:  
EMPERADOR DARK, PALISSANDRO BLU NUVOLATO, PALISSANDRO FIORITO OR SAHARA NOIR

## STANDARD FEATURES

- HARD WOOD FRAME AND POLYURETHANE COVERED WITH LEATHER  
- GLASS TOP AVAILABLE IN: SMOKED OR WHITE (RAL 9003)

## NOTES

- CERAMIC TOP AVAILABLE IN:  
TERRA, ANTRACITE, NOIR DESIR OR OSSIDO BRUNO COLOR

- MARBLE TOP AVAILABLE IN:  
EMPERADOR DARK, PALISSANDRO BLU NUVOLATO, PALISSANDRO FIORITO OR SAHARA NOIR

## STANDARD FEATURES

- PAINTED METAL BASE  
- GLASS TOP AVAILABLE IN: SMOKED OR WHITE (RAL 9003)

## NOTES

- BASE AVAILABLE IN: CHROME OR DARK CHROME-TITANIO, BURNISHED ALUMINIUM, BURNISHED COPPER

- CERAMIC TOP AVAILABLE IN:  
TERRA, ANTRACITE, NOIR DESIR OR OSSIDO BRUNO COLOR

- MARBLE TOP AVAILABLE IN:  
EMPERADOR DARK, PALISSANDRO BLU NUVOLATO, PALISSANDRO FIORITO OR SAHARA NOIR

## STANDARD FEATURES

- POLYURETHANE RESIN FRAME COVERED WITH LEATHER  
- METAL INSERT AVAILABLE IN:  
CHROME, DARK CHROME-TITANIO, BURNISHED ALUMINIUM, BURNISHED COPPER OR PAINTED METAL  
- GLASS TOP AVAILABLE IN: SMOKED OR WHITE (RAL 9003)

## NOTES

- CERAMIC TOP AVAILABLE IN:  
TERRA, ANTRACITE, NOIR DESIR OR OSSIDO BRUNO COLOR

- MARBLE TOP AVAILABLE IN:  
EMPERADOR DARK, PALISSANDRO BLU NUVOLATO, PALISSANDRO FIORITO OR SAHARA NOIR

T04  
top Ø 40 - 16"



T05  
top Ø 50 - 20"



T06  
top Ø 100 - 39"

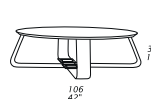

T07  
top Ø 120 - 47"

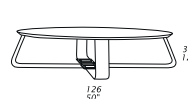

T08

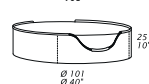

T09



T14

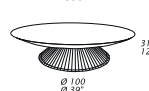

T15



T16

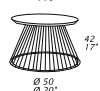

T40



T17



T18



Dimensions: the first figure shows sizes in centimeters, the second in inches.

Each piece is made by hand and has its own uniqueness. Measures may vary with a tolerance up to 3%.

Technical sheet

## COFFEE TABLES

Design Giuseppe Viganò

## STANDARD FEATURES

- BASE AVAILABLE IN: CHROME OR DARK CHROME-TITANIO COVERED WITH LEATHER
- GLASS TOP AVAILABLE IN: SMOKED OR WHITE (RAL 9003)

## NOTES

- CERAMIC TOP AVAILABLE IN:  
TERRA, ANTRACITE, NOIR DESIR OR OSSIDO BRUNO COLOR

T26

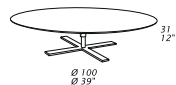

T27

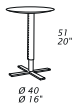

T28



## STANDARD FEATURES

- WOOD LEGS FINISH:  
NOCE CANALETTO OR FRASSINO
- LEATHER TOP WITH GROS GRAIN OR LEATHER PIPING

## NOTES

- CERAMIC TOP AVAILABLE IN:  
TERRA, ANTRACITE, NOIR DESIR OR OSSIDO BRUNO COLOR

T29

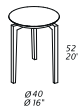

T30



T31



## WOOD LEGS FINISHES



Noce Canaletto



Frassino

## STANDARD FEATURES

- BASE AVAILABLE IN: CHROME, DARK CHROME-TITANIO, BURNISHED ALUMINIUM, BURNISHED COPPER, PAINTED METAL OR COVERED WITH LEATHER
- BUCKLE AVAILABLE IN: CHROME, DARK CHROME-TITANIO, BURNISHED ALUMINIUM, BURNISHED COPPER, PAINTED METAL OR COVERED WITH LEATHER
- GLASS TOP AVAILABLE IN: SMOKED OR WHITE (RAL 9003)

## NOTES

- CERAMIC TOP AVAILABLE IN:  
TERRA, ANTRACITE, NOIR DESIR OR OSSIDO BRUNO COLOR

- MARBLE TOP AVAILABLE IN:  
EMPERADOR DARK, PALISSANDRO BLU NUVOLATO, PALISSANDRO FIORITO OR SAHARA NOIR

T120B

top 40x40 - 16x16"



T121B

top 50x50 - 20x20"



T122B

top 100x100 - 39x39"



T123B

top 120x100 - 47x39"

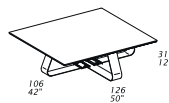

## COFFEE TABLES

Design Giuseppe Viganò

## STANDARD FEATURES

- A: DARK CHROME-TITANIO, BURNISHED ALUMINIUM, BURNISHED COPPER OR PAINTED BASE
- B: CHROME, DARK CHROME-TITANIO, BURNISHED ALUMINIUM, BURNISHED COPPER OR PAINTED SUPPORTS
- GLASS TOP AVAILABLE IN: SMOKED OR WHITE (RAL 9003)

## NOTES

- CERAMIC TOP AVAILABLE IN:  
TERRA, ANTRACITE, NOIR DESIR OR OSSIDO BRUNO COLOR

T125B

top 40x40 - 16x16"

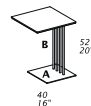

T126B

top 50x50 - 20x20"

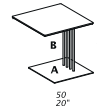

T127B

top 100x100 - 39x39"

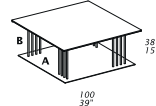

T128B

top 100x50 - 39x20"

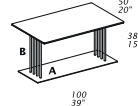

## STANDARD FEATURES

- BASE AVAILABLE IN: CHROME, DARK CHROME-TITANIO, BURNISHED ALUMINIUM, BURNISHED COPPER OR PAINTED METAL
- GLASS TOP AVAILABLE IN: SMOKED OR WHITE (RAL 9003)

## NOTES

- CERAMIC TOP AVAILABLE IN:  
TERRA, ANTRACITE, NOIR DESIR OR OSSIDO BRUNO COLOR

T140B

top 100x100 - 39x39"

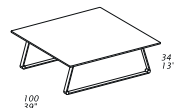

T141B

top 80x80 - 31x31"

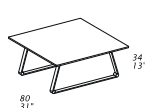

T142B

top 50x50 - 20x20"

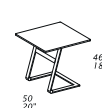

T143B

top 100x50 - 39x20"

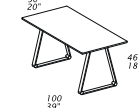

## STANDARD FEATURES

- BASE AVAILABLE IN: CHROME, DARK CHROME-TITANIO, BURNISHED ALUMINIUM, BURNISHED COPPER, OR PAINTED METAL
- GLASS TOP AVAILABLE IN: SMOKED OR WHITE (RAL 9003)
- CERAMIC TOP AVAILABLE IN:  
TERRA, ANTRACITE, NOIR DESIR OR OSSIDO BRUNO COLOR

## NOTES

- MARBLE TOP AVAILABLE IN:  
EMPERADOR DARK, PALISSANDRO BLU NUVOLATO, PALISSANDRO FIORITO OR SAHARA NOIR

T155B

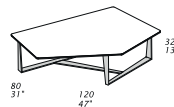

T156B

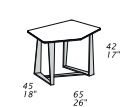

Dimensions: the first figure shows sizes in centimeters, the second in inches.

Each piece is made by hand and has its own uniqueness. Measures may vary with a tolerance up to 3%.

## BROOKLYN

Design Giuseppe Viganò

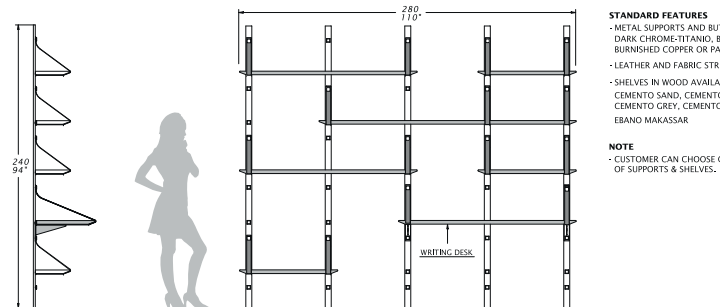

## STANDARD FEATURES

- METAL SUPPORTS AND BUTTONS AVAILABLE IN: DARK CHROME-TITANIO, BURNISHED ALUMINIUM, BURNISHED COPPER OR PAINTED METAL
- LEATHER AND FABRIC STRINGS
- SHELVES IN WOOD AVAILABLE IN COLORS: CEMENTO SAND, CEMENTO TAUPE, CEMENTO GREY, CEMENTO BLACK, EBANO MAKASSAR

## NOTE

- CUSTOMER CAN CHOOSE CONFIGURATIONS OF SUPPORTS & SHELVES.

## SHELVES

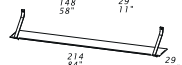
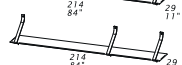
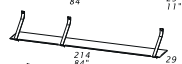
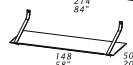
GC007  
CENTRAL SHELF- TIES ARE INCLUDED  
IN SHELFGC008  
CENTRAL SHELFGC009  
CENTRAL SHELFGD009  
DX SHELFGS009  
SX SHELFGC010  
WRITING DESK

## SUPPORTS

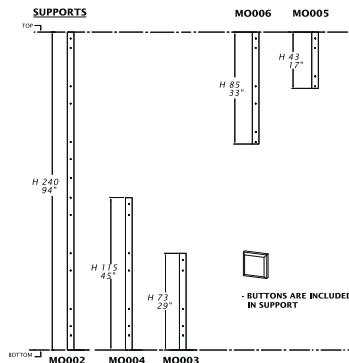

## SHELVES FINISHES

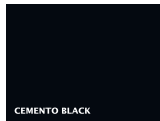
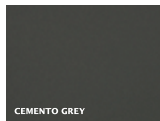
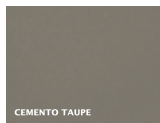
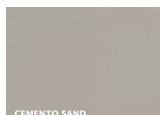

## BASKET LAMPS

Design Giuseppe Viganò

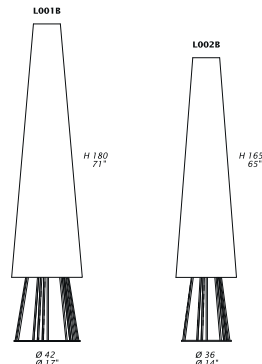

## STANDARD FEATURES

- FLOOR LAMP WITH METAL FRAME AVAILABLE IN ALL GAMMA FINISHING OPTIONS.
- LAMP SHADE IN VISCOSE COUPLED WITH PVC, AVAILABLE IN THE FOLLOWING COLORS:



## TECHNICAL SHEET

- LIGHT SOURCES NOT SUPPLIED
- MAX 150 W HALO / LED - FLUO COMPATIBLE
- SOCKET E27, VOLTAGE 220 - 240 V
- SOCKET E26, VOLTAGE 110 - 120 V

Dimensions: the first figure shows sizes in centimeters, the second in inches.  
Each piece is made by hand and has its own uniqueness. Measures may vary with a tolerance up to 3%.

Technical sheet

## MIRRORS

Design Giuseppe Viganò

## STANDARD FEATURES

- HARD WOOD FRAME COVERED WITH LEATHER

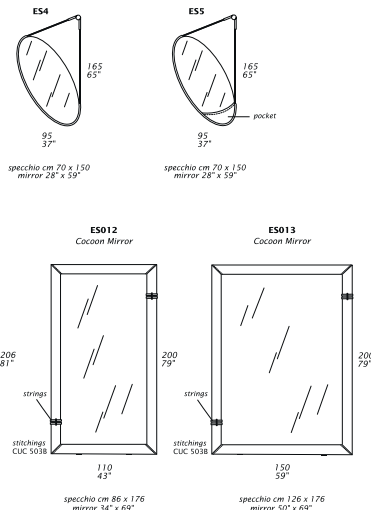

Dimensions: the first figure shows sizes in centimeters, the second in inches.  
Each piece is made by hand and has its own uniqueness. Measures may vary with a tolerance up to 3%.

Technical sheet

## BAGS

Design Giuseppe Viganò

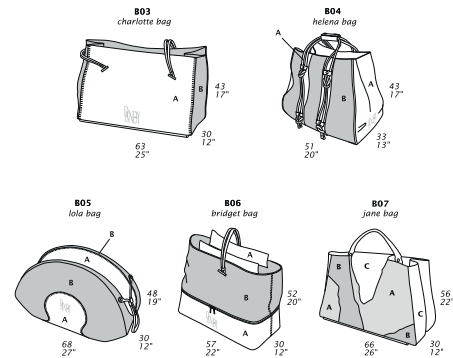

Dimensions: the first figure shows sizes in centimeters, the second in inches.  
Each piece is made by hand and has its own uniqueness. Measures may vary with a tolerance up to 3%.  
Dandy's Newspapers Bag, coordinated in the same cover and style to the sofa.

Technical sheet

## BIG BAG

Design Giuseppe Viganò

STANDARD FEATURES  
- HARD WOOD FRAME  
- PADDING IN POLYURETHANE

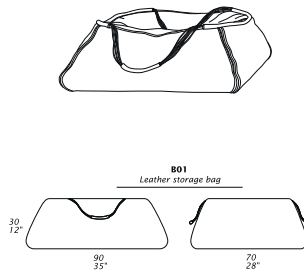

Dimensions: the first figure shows sizes in centimeters, the second in inches.  
Each piece is made by hand and has its own uniqueness. Measures may vary with a tolerance up to 3%.

Technical sheet

## SMART STOOLS

Design Giuseppe Viganò

- TOP AVAILABLE ON UP-CHARGE IN:  
SMOKED OR WHITE (RAL 9003) GLASS  
CERAMIC TERRA, ANTRACITE, NOIR DESIR OR OSSIDO BRUNO COLOR

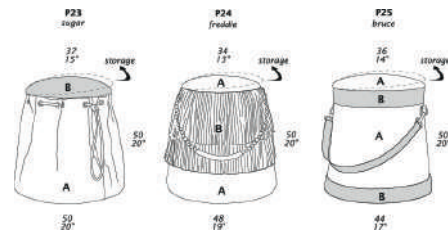

Dimensions: the first figure shows sizes in centimeters, the second in inches.  
Each piece is made by hand and has its own uniqueness. Measures may vary with a tolerance up to 3%.  
Smart stools, pouf and newspapers Bag, coordinated in the same cover and style to the sofa.

Technical sheet

## SMART ACCESSORIES

Design Giuseppe Viganò

TABLE  
- TOP AVAILABLE IN:  
SMOKED OR WHITE (RAL 9003) GLASS  
CERAMIC TERRA, ANTRACITE, NOIR DESIR OR OSSIDO BRUNO COLOR

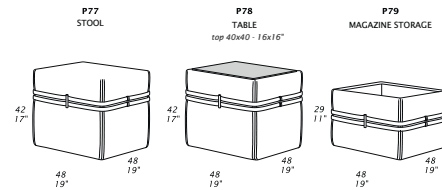

Dimensions: the first figure shows sizes in centimeters, the second in inches.  
Each piece is made by hand and has its own uniqueness. Measures may vary with a tolerance up to 3%.  
Smart accessories coordinated in the same cover and style to the sofa.

Technical sheet

# OTTOMANS

Design Giuseppe Viganò

**STANDARD FEATURES**  
 - HARD WOOD FRAME  
 - PADDING IN POLYURETHANE

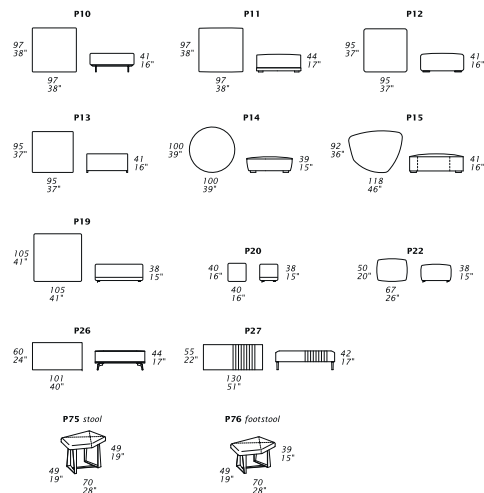

Dimensions: the first figure shows sizes in centimeters, the second in inches.  
 Each piece is made by hand and has its own uniqueness. Measures may vary with a tolerance up to 3%.

Technical sheet

# FLOOR PILLOWS

Design Giuseppe Viganò

**STANDARD FEATURES**  
 - PADDING IN POLYURETHANE COVERED WITH FEATHER

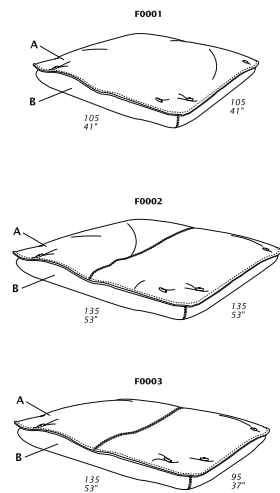

Dimensions: the first figure shows sizes in centimeters, the second in inches.  
 Each piece is made by hand and has its own uniqueness. Measures may vary with a tolerance up to 3%.

Technical sheet

# ROYAL PILLOWS

Design Giuseppe Viganò

**STANDARD FEATURES**  
 - PILLOWS WITH FEATHER FILLING

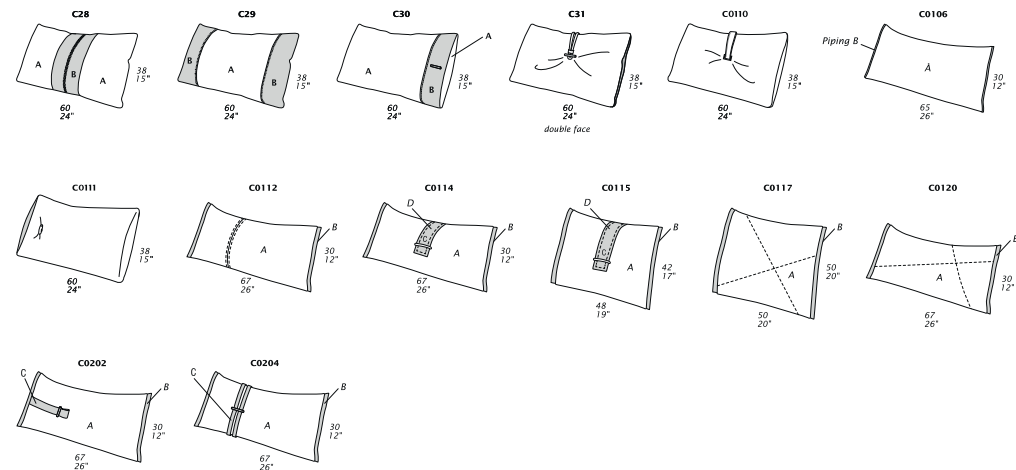

Dimensions: the first figure shows sizes in centimeters, the second in inches.  
 Each piece is made by hand and has its own uniqueness. Measures may vary with a tolerance up to 3%.

Technical sheet

# PILLOWS

Design Giuseppe Viganò

## STANDARD FEATURES

- PILLOWS WITH FEATHER FILLING

## NOTE

- AVAILABLE WITH ANY STITCHING OF OUR COLLECTION

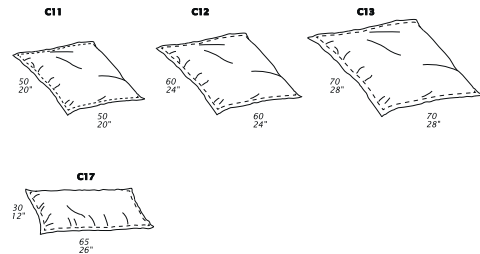

C17

65  
26"

Dimensions: the first figure shows sizes in centimeters, the second in inches.  
Each piece is made by hand and has its own uniqueness. Measures may vary with a tolerance up to 3%.

Technical sheet

# CUSTOMIZING

## CERAMIC TOP FINISHES

TERRA COLOR

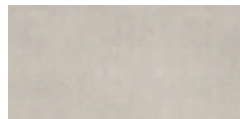

ANTRACITE COLOR

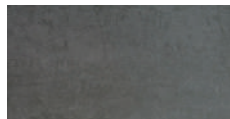

NOIR DESIR COLOR

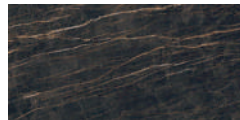

OSSIDO BRUNO COLOR



## MARBLE TOP FINISHES

PALISSANDRO FIORITO



PALISSANDRO BLU NUVOLATO



SAHARA NOIR

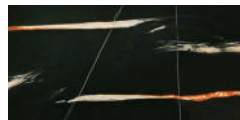

EMPERADOR DARK



**N.B. EACH MARBLE, BEING A NATURAL PRODUCT, IS A ONE-OF-A-KIND PIECE AND CAN THEREFORE EXHIBIT COLOUR AND STRUCTURAL DIFFERENCES.**

# CUSTOMIZING

## METAL LEGS FINISHES

CHROME



DARK CHROME - TITANIO

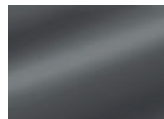

METALLIC GREY

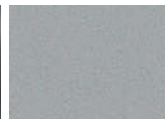

METALLIC ANTHRACITE

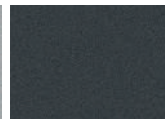

BURNISHED ALUMINIUM

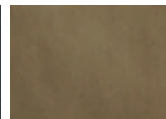

BURNISHED COPPER

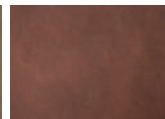

RAL 9003 - SIGNAL WHITE

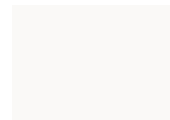

RAL 7044 - SILK GREY



RAL 3005 - WINE RED



RAL 8019 - GREY BROWN



RAL 9005 - JET BLACK



## WOOD LEGS FINISHES

ALUMINIUM COL.8

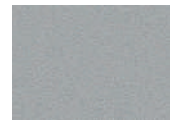

BLACK COL.3



WALNUT COL.1



WENGÉ COL.6



# AD STUDIO VIGANÒ

PHOTO EOLO RADONI  
PREPRESS MONOGRAMMA  
PRINT GRAFICA GIOIA

**D**  
**ANDY**  
HOME  
collection

100% hand made in Italy

by

GAMMA ARREDAMENTI INTERNATIONAL Spa

HEADQUARTERS

Via PITAGORA 3 - 47121 FORLÌ (FC) - Italia

PH. +39 0543 708311

FAX +39 0543 701795

e-mail: [info@gammarr.it](mailto:info@gammarr.it)

U.S.A. GAMMA Inc.

520 SOUTH HAMILTON STREET - HIGH POINT, NC 27260

PH. +1 336 886 8060

FAX +1 336 886 8059

e-mail: [infousa@gammarr.it](mailto:infousa@gammarr.it)

---

[www.dandyhome.it](http://www.dandyhome.it)

---